



Banner

THE POWER COMPANY



TECHNICAL GUIDE

bannerbatterien.com

LEADING
COMPANIES OF AUSTRIA



CONTENTS.

Introduction	Page 5
Banner website	Page 6
Technical principles	Page 8
Battery use	Page 22
Energy household	Page 46
Service	Page 58
Lexicon	Page 64
Sales region	Page 68



Banner

THE POWER COMPANY

**Banner POWER
INSIDE!**
OE-QUALITY
FROM AUSTRIA.

Banner batteries meet the highest demands of the automotive industry, which is why many leading brand vehicles roll off the production line with a Banner battery inside.

bannerbatterien.com

LEADING
COMPANIES OF AUSTRIA





INTRODUCTION

Banner is one of Europe's largest battery manufacturers and produces and markets starter batteries that constantly meet the highest demands of current vehicles, as well as traction-device-stationary batteries, wheel weights and a tailor-made programme of accessories.

Banner is an independent, family-owned company with a plant in Linz/Austria, which produces quality certified according to ISO 9001 and IATF 16949. Banner also makes a valuable contribution to environmental protection through battery collection, complete recycling and a management system in line with ISO 14001.

THE POWER PAGE ON THE WORLDWIDE WEB.

Detailed information concerning Banner and its products, current news and offers are available on the Banner Power Page.

▶ **Battery know-how**

The knowledge communicated here is of ever-growing importance. Learn more about the subject of start-stop, along with tips and tricks, how-to videos and a whole range of other topics...

▶ **Battery searches**

Find the optimum product for your application!

▶ **Retailer searches**

Find Banner's official sales partner in your vicinity!



Banner
THE POWER COMPANY

PRODUCTS BATTERY SEARCH RETAILER SEARCH BATTERY KNOWLEDGE COMPANY



PARTNER PORTAL

CONTACT

SEARCH

Only display article with video

TM SEARCHING FOR ...



Battery tip: So your car battery doesn't get fried.
How best to protect your battery in summer?

If winter comes around and it turns out you need a new battery, the summer heat is usually to blame.



Battery tip: Conversion from original US battery to DIN Euro type
It's often that simple!

If an original side terminal battery is installed in your US car, you can often use a commercially available European DIN battery type with the battery clamps for US cars and thus also save money!



Banner Lexicon: Decarbonisation
What is decarbonisation?

Decarbonisation is THE key term in the field of environment & sustainability, with the aim of stopping global warming and thus climate change.



Battery knowledge

WHAT IS A BATTERY.

A battery is a device consisting of several, identical, interconnected galvanic cells, which is able to store chemical energy. Voltage is created whenever two differing metals are found in an electrolyte solution (galvanic cell). This voltage depends upon the type of metal (electrochemical voltage series), the solution concentration and the temperature. In the case of lead-acid batteries, the positive electrode is made of lead oxide and the negative electrode of lead. Diluted sulphuric acid is employed as electrolyte and provides a rated voltage of 2 V per cell. Therefore, in a 12 V battery, six cells must be interconnected in series.

Dependent upon whether or not batteries can be recharged, a differentiation is made between primary elements that can only be discharged once and secondary elements, which can be recharged several times during their service life.

A further differentiation is made with regard to the area of application. Device batteries are used mainly for the supply of small items of electrical equipment and traction batteries for electrical vehicles, while among other applications, stationary batteries are employed for the provision of an uninterrupted power supply.

As a rule, **starter batteries** (= SLI batteries – starting, lighting, ignition) are used for the ignition of combustion engines. They supply a large amount of energy for a short period and are able to initiate several thousand starting procedures.

Conventional, EFB and AMG batteries are all used for starting.

In addition, a considerable number of battery types, which for example differ with regard to their mesh technology (alloys), as well as vented and valve regulated batteries, are available on the market.

Although the principle of the lead battery is relatively old, it remains in successful current use. The lead battery continues to offer the best compromise between reliability, usability, robustness and price.

BATTERY DESIGN.

- ▶ A 12 V battery consists of six cells interconnected in series (rated voltage of a lead-acid cell = 2 V), which are installed in a battery casing divided by separating walls and connected in series by a cell connector.
- ▶ Each cell consists of a plate block comprised of a positive and a negative plate set.
- ▶ Separators keep the electrodes with differing polarity apart. In the case of conventional batteries, a polyethylene separator is used, while in EFB batteries an additional polyester web is employed. In AGM batteries a highly absorbent glass mat separator is utilised, which binds in the electrolyte.
- ▶ The electrodes are formed by a lead grid (expanded metal, Con-Cast and book casting technology) and active mass. The individual electrodes are linked to a both negative and positive plate set by the connector.
- ▶ Diluted sulphuric acid serves as electrolyte (acid density of a fully charged sealed battery: 1.28-0.01+0.04 kg/l).
- ▶ Differing pole diameters (the positive pole is thicker than the negative pole) prevent the false connection of the battery.

- ▶ Batteries are closed using a number of differing lid designs. In the case of AGM batteries, apart from a reinforced casing, special screws are employed that provide an airtight sealing.

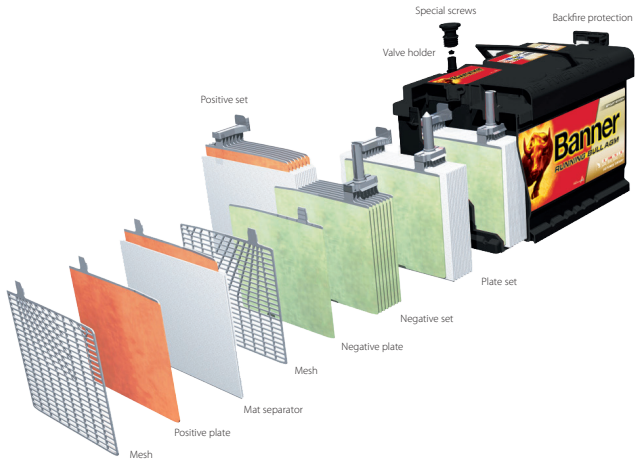

BATTERY FUNCTION.

Two electrodes, which are linked inside the cell by a solution (electrolyte), are required for the conversion of chemical energy into electrical energy (galvanic process). In a charged condition, the electrode plates are comprised of lead and lead oxide. The positive electrode consists of lead oxide and the negative electrode of lead. Diluted sulphuric acid forms the electrolyte, which ensures the flow of ions between the electrodes. The electrolyte can be liquid, gel-like or be bound into a glass mat, as is the case in an AGM battery.

When the battery supplies power, the negative charged sulphate ions (SO_4^{2-}) from the sulphuric acid (H_2SO_4) are bound on the plates. Both plates are gradually turned into lead sulphate (PbSO_4). The uncharged lead atoms (Pb) of the lead plate are positively charged twice (Pb^{2+}) and the previously fourfold positively charged lead ions (Pb^{4+}) in the lead oxide plate are also positively charged twice.

In order to compensate for the charge gradient, electrons flow from the lead plate to the lead oxide plate. The battery supplies current.

Charged
 $PbO_2 + Pb + 2H_2SO_4$

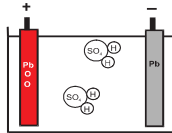

Current output

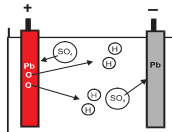

Discharged
 $PbSO_4 + PbSO_4 + 2H_2O$

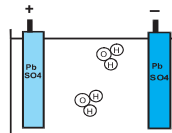

Charged

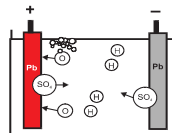

Acid density 1.28

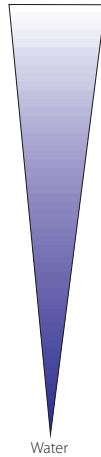

Chem. Symbol key

- Pb.....Lead
- PbO₂..... Lead oxide
- H₂SO₄..... Sulphuric acid
- PbSO₄.....Lead sulphate
- H₂O.....Water
- H.....Hydrogen
- O.....Oxygen
- SO₄.....Sulphate

STATE OF CHARGE.

Charged condition	Conventional ba	
	Acid density + 25°C [kg/l]	(
100 %	Approx. 1.28	>
90 %	Approx. 1.26	>
80 %	Approx. 1.24	>
70 %	Approx. 1.22	>
60 %	Approx. 1.20	>
50 %	Approx. 1.18	>
20 %	Approx. 1.10	>
0 - 10 %	Approx. 1.05	>

No vehicle installation

Installation in vehicle

battery (vented)	AGM battery (valve regulated)
Open circuit voltage [V]	Open circuit voltage [V]
> 12.70	> 12.90
> 12.60	> 12.75
> 12.50	> 12.65
> 12.40	> 12.50
> 12.30	> 12.40
> 12.20	> 12.25
> 11.80	> 11.80
> 10.50	> 10.50

At the latest, batteries reaching an open circuit voltage of 12.50 V must be recharged immediately.

SELF-DISCHARGE.

After a certain time, even when the battery is not connected to any consumers, it becomes electrically empty. This occurrence is described as self-discharge and is caused by the chemical processes in the battery.

The extent of self-discharge depends upon the temperature, the acid-mass ratio and the battery technology.

A change in the storage temperature of 10°C results in a doubling of self-discharge (Arrhenius' Law). Self-discharge has a special influence in the case of seasonally employed vehicles such as those used in agriculture and the construction industry, motorcycles, caravans and convertibles.

In order to prevent irreparable damage, at the latest, batteries reaching an open circuit voltage of 12.50 V must be recharged immediately.



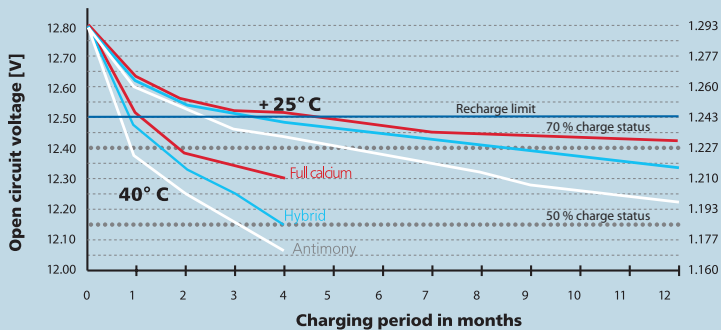

Store batteries in a cool (between 0° and + 25°C) and dry place.

SERIES/PARALLEL CONNECTION

Please note:

- ▶ Both batteries must have the same type designation.
- ▶ Both batteries must be of roughly the same age.
- ▶ Both batteries must have the same charge status.
- ▶ The connecting lines must have sufficient dimensions and be as short as possible.
- ▶ Always exchange both batteries!

Should the aforementioned recommendations not be followed, differing internal resistance of the individual batteries causes a corresponding voltage distribution and thus an asymmetrical load during the loading and discharge phase.

The charging equaliser creates a uniform charge status between two batteries used in series.

During parallel connection, partially high levels of transient current flow between the batteries. Where structurally possible, it is therefore recommended that only a single battery with a higher capacity is employed.



Series and parallel circuits

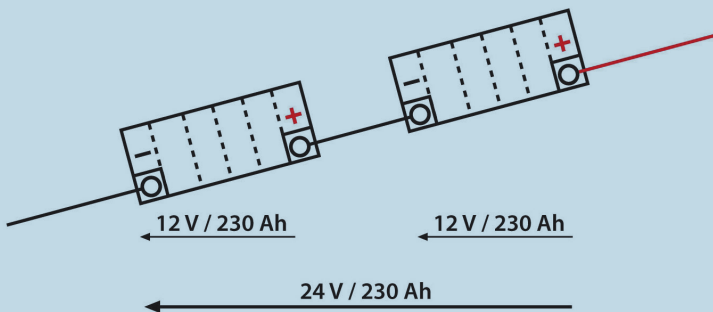

In the case of serial connections (=line connection) the voltages of the individual batteries are combined. Therefore, in order to create a 24V electrical system, two 12V batteries must be connected in series.

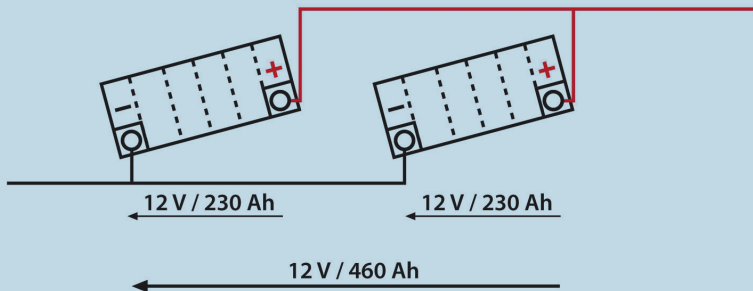

In a parallel connection, both the individual capacities and the cold start current of the individual batteries are combined.

OUTPUT CAPACITY AND ENERGY REQUIREMENT.

A battery has its maximum output capacity at a room temperature of +25°C. The colder the temperature, the slower the chemical processes in the battery and hence the lower its output capacity.

Engines also prefer warm temperatures, as the engine oil is very fluid and friction is reduced. However, as the temperature falls the energy required for starting increases massively. Consequently, the highest starting power is required when the battery has a poor output capacity.

Therefore, many batteries tend to fail in the cold period of the year.



Avoid winter starting problems

Battery output capacity

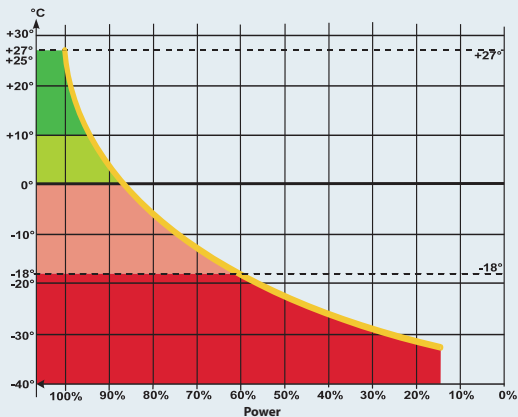

Energy requirement of the engine during starting

Engine energy requirement

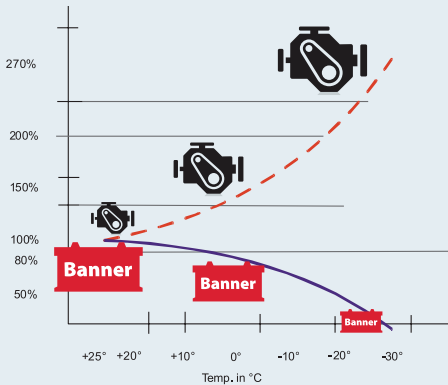

WARNING!

Please obtain additional information regarding the secure handling of lead batteries from the product datasheet concerning starter battery safety on our homepage under the respective battery type, or via the QR code.

The screenshot shows the Banner website homepage. At the top left is the Banner logo with the tagline 'THE POWER COMPANY'. The navigation menu includes: PRODUCTS, BATTERY SEARCH, RETAILER SEARCH, SUPPORT, COMPANY, PARTNER PORTAL, CONTACT, and SEARCH. The main banner features a woman sitting in the back of a car with a red Bull AGM battery. Text on the banner reads: 'RUNNING BULL AGM TOP START-STOP PERFORMANCE'. Below this are buttons for 'BATTERY SEARCH' and 'RETAILER SEARCH'. At the bottom, a section titled 'LOOKING FOR THE RIGHT BATTERY?' has four categories: Cars, Cars with Start Stop Systems, Construction Machinery, and Agricultural Machinery, each with a representative image.

Safety data sheet



Warnings and safety instructions for lead-acid batteries



Adhere to the information printed on the batteries, in the instructions for use and the vehicle operating manual.



Wear eye protection.



Keep children away from acid and batteries.



Danger of explosions:

- A highly explosive oxyhydrogen gas mixture is created during battery charging.

Open flames, sparks, open lights and smoking are prohibited:



- Avoid sparks when handling cables and electrical devices! Avoid short circuits!

Danger of chemical burns:



- Battery acid can cause severe burns therefore.

- Wear gloves and eye protection!

- Do not tip the battery, as acid can escape from the degassing valves.

First aid:

- In the case of acid splashes in the eyes, immediately rinse out with clean water for several minutes! Then consult a doctor without delay!



- Treat acid splashes on the skin or clothing with an acid neutralizer or soap and rinse with large amounts of water.

- Should acid be swallowed, consult a doctor immediately!

Warning:

- Do not subject batteries to direct daylight.

- Discharged batteries can freeze; therefore use frost-free storage.



Disposal:

- Used batteries should be handed in at a collection point. The information provided under Item 1 should be taken into account during transport.



Never dispose of batteries with household waste!

BATTERY TECHNOLOGIES.

AGM

The absorbent glass mat (AGM) battery is of recombination design.

A glass mat separator absorbs the acid and leaves sufficient pores free, in order to facilitate oxygen diffusion from the positive to the negative plate. On the negative plate, the oxygen combines with lead to form lead oxide. This lead oxide then reacts with the sulphuric acid to create lead sulphate, whereby water results as a reaction product. Charging then causes the lead sulphate to convert back into metallic lead. As a consequence there is no water loss!

In view of the predominant cell overpressure, the battery casing is of even more stable design and the lid is fitted with special overpressure valves, which may never be opened. Moreover, compact installation presses the electrode plates so closely together that sludging is reduced greatly, thus providing very high cyclical and vibration resistance.

If too much gas is created due to excessive charging voltages or very high temperatures, it can no longer be entirely recombined. Consequently, the pressure in the battery rises continually until the safety valve opens = thermal runaway.

Formed, complete recombination is no longer possible. Consequently, the pressure in the battery rises continually until the safety valve opens = thermal runaway.



Banner recommendation: For safety reasons, when installing the battery indoors always use a degassing hose, which in an emergency will conduct the gas outwards.



Battery degassing

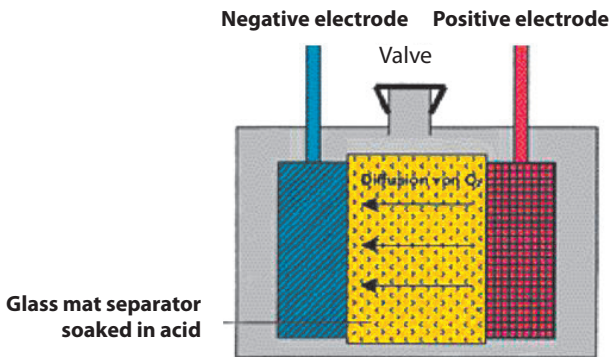

AGM

TECHNICAL DATA AND INFORMATION

- ▶ Valve-regulated lead acid battery (VRLA)
- ▶ Five types with capacities of 60 to 105 Ah are on offer
- ▶ Threefold cycle resistance as compared to standard starter batteries: highest M3 classification pursuant to EN 50342-1:2016
- ▶ Leak-proof owing to the electrolyte being bound in (absorbent glass mat - AGM)
- ▶ Absolute maintenance-free due to recombination technology
- ▶ High V3 vibration resistance pursuant to EN 50342-1:2016
- ▶ Highest start performance thanks to very low internal resistance
- ▶ Installation in a lateral position possible (max. 90° angle of inclination)
- ▶ Flexible use as a starter and electrical system battery
- ▶ OEM quality





Battery degassing

EFB / AFB / ECM

The enhanced flooded battery (EFB) is an upgraded conventional battery.

Special additives and the use of a polyester scrim lend the active mass additional hold. As a result, the battery has improved cyclical resistance and is extremely vibration resistant.



Banner recommendation: For safety reasons, when installing the battery indoors always use a degassing hose, which in an emergency will conduct the gas outwards.

TECHNICAL DATA AND INFORMATION

- ▶ Range of eleven types with capacities of between 38 Ah and 95 Ah
- ▶ Web cover on the separator and special active mass compound
- ▶ Twice the cyclical life, as compared to standard starter batteries; M2 classification pursuant to EN 50342-1:2016
- ▶ High V3 vibration resistance in line with EN 50342-1:2016
- ▶ Measures to reduce acid stratification and improve charge intake
- ▶ "Carbon loaded". The carbon additives result in a marked reduction in charging times
- ▶ The Double Top ensures maximum leakage protection and operational safety
- ▶ Absolutely maintenance-free due to modern calcium mesh technology
- ▶ OEM quality

AFB and ECM batteries can be replaced by Banner Running Bull EFBs with an identical box and the similar performance class.

AFB = Advanced Flooded Battery

ECM = Enhanced Cyclic Mat



CONVENTIONAL LEAD-ACID BATTERY

Since its development over a century ago, the conventional lead-acid battery has been continually further developed and is still in successful use. It continues to offer the best compromise between reliability, usability, robustness and price, as well as providing OEM quality for retrofitting. The Power Bull, which was designed according to BMW's and VW's first fitting standards, is Banner's premium starter battery for modern vehicles, as well as the first choice as a replacement battery.

TECHNICAL DATA AND INFORMATION

- ▶ Robust cyclical behaviour: E2 classification pursuant to EN 50342-1:2016
- ▶ Double Top equals twice the leak protection. 100% leak proof up to a maximum angle of 55°
- ▶ Absolutely maintenance-free due to modern calcium technology
- ▶ Optimum cold start values, maximum starting power
- ▶ Extensive coverage of the European and Asian vehicle fleets owing to 28 battery types with 40 Ah to 110 Ah
- ▶ Safe against vibrations due to the bonding of the plates to the floor and robust cell connections; V2 classification pursuant to EN 50342-1:2016
- ▶ Improved backfire and ESD safety (against electrostatic discharge)



Banner recommendation: For safety reasons, when installing the battery always employ a degassing hose in the vehicle interior, which will conduct the gases outwards.



Battery degassing



ENERGY BULL

With the Energy Bull, Banner offers a special battery for hobbies and leisure. The characteristics of the Energy Bull make it robust and the ideal energy source for camping/caravans, boats and many other applications up to signal systems and traction batteries for electrical motors. For example, in combination with bag separators and a special mass composition, the robust mesh structure ensures extreme cyclical resistance.

TECHNICAL DATA AND INFORMATION

- ▶ Extremely cyclical resistant and durable with four times the cyclical resistance of a starter battery
- ▶ Maintenance-friendly, easy to open and with MIN/MAX markings on the transparent box
- ▶ A safeguard integrated into the surge protectors in the battery lid guarantees backfire safety
- ▶ Low maintenance requirement due to minimal water consumption and self-discharge
- ▶ Simple charging using a standard commercial charger
- ▶ Vibration-resistant owing to the bonding of the plates to the floor and glass web lined bag separators; high V3 classification pursuant to EN 50342-1:2016
- ▶ Optimised capacity and hence ideal for cyclical loads
- ▶ Environmental and user-friendly, as delivered filled and charged
- ▶ Practical handles



Banner recommendation: For safety reasons, when installing the battery indoors always use a degassing hose, which in an emergency will conduct the gas outwards.



Battery degassing



CALCULATING THE CAPACITY REQUIREMENT.

How to calculate the correct capacity for the battery in your electrical system. The example below shows how you can calculate the electricity requirement for a mobile home.

Device	P performance in W	U voltage in V	Current I – P/U in A	Activation time in h	Capacity K = Ixt in Ah
Mini-fridge	100	12	8.3	8	66
Mini-TV	80		6.7	2	13
Lighting	40		3.3	4	13
Kettle	200		16.7	0,15	3
Hotplates	500		41.7	0,2	8
Total					103
Required battery capacity (= total multiplied by a safety factor of 1.7)					175

Required battery: Energy Bull 96081 K5 = 180 Ah

If the average activation time amounts to approx. 5 hours, then K5 is employed. K 20 is used for 20 hours and K100 for around 100 hours.

In order to prevent deep discharging, as a rule a safety factor of 1.7 should be used for wet batteries (1.3 for recombination AGM and gel batteries).



What does capacity mean?



THE CORRECT CHOICE OF A BATTERY.

The following guidelines must be followed in order to select the right replacement battery:

Note the technology of the original battery (upgrades are permissible).

- ▶ If the original battery was an AGM, the replacement must also be an AGM.
- ▶ Where EFB batteries were installed originally, they must also be used for retrofits. In order to prolong battery life, under certain circumstances, AGM batteries may also be employed. In the case of a technology upgrade in stop/start vehicles with a battery management system (BMS), the new battery must be attuned to in the system. The Banner Battery Service Tool (BBST) is ideal for this purpose.
- ▶ Where conventional batteries were originally installed, EFB or AGM batteries can be retrofitted.

Retrofit with the original dimensions.

- ▶ Where there is space for batteries with a height of 190 mm, these should be retrofitted instead of batteries with a height of 175 mm. Owing to this 15 mm difference, the taller batteries possess a greater acid volume, which tends to lead to longer battery life.

Retrofitting with powerful conventional batteries.

- ▶ Wherever possible, battery types with the biggest capacity (not the maximum cold start performance) should be selected, or the largest battery suitable for installation employed.

- ▶ Under no circumstances should a replacement battery be installed for reasons of price, when this has a far lower capacity than that of the original.

Retrofitting with powerful start-stop batteries (AGM, EFB).

- ▶ The replacement battery should have a box identical to that of the original and be in a similar performance class.
- ▶ Slight capacity and cold start deviations have no effect upon safe starting and optimum electrical system supply.

Retrofitted energy consumers require a more powerful battery.

- ▶ Retrofitted energy consumers such as stationary heating, sound systems, cool boxes, etc. mean that the output of the original battery is insufficient and therefore battery life will be drastically shortened.

Our Battery Finder on the Banner homepage also provides assistance!

<https://www.bannerbatterien.com/en/Battery-search>



Choosing the right battery

BATTERY INSTALLATION AND REMOVAL.

Always heed the safety warnings!

- ▶ Only install batteries with an open circuit voltage of $>12.50\text{ V}$ in a vehicle!
- ▶ Follow the vehicle instructions.
- ▶ Voltage interruptions can result in data loss. A Memory Saver provides assistance.
- ▶ Before fitting or removing the battery, switch off the engine and all power consumers.
- ▶ Avoid short circuits due to tools.
- ▶ When removing the battery, first disconnect the negative (-) terminal and then the positive (+) terminal.
- ▶ Prior to fitting the battery, clean the battery compartment.
- ▶ Ensure that the battery is secured tightly.
- ▶ Clean terminals and battery clips and lubricate slightly with acid-free grease.
- ▶ When fitting the battery first connect the positive (+) terminal and then the negative (-) terminal. Ensure that the clips are secured.
- ▶ Original parts and sleeves are to be put back in place.



Banner recommendation: For safety reasons, when installing the battery always employ a degassing hose in the vehicle interior, which will conduct the gases outwards.



Battery degassing



How-to change the car battery



STORAGE AND TRANSPORT.

Storage

- ▶ Only store fully charged batteries with short circuit protection.
- ▶ Batteries are to be kept in a dry, light-protected and cool (frost-free) place.
- ▶ The open circuit voltage of the batteries is to be checked regularly and at the latest, when this stands at 12.50 V, the batteries are to be recharged.
- ▶ If a battery is to be taken out of service in the winter months, it should be removed from the vehicle.
- ▶ If the battery is left in the vehicle, the negative terminal should be disconnected.
- ▶ As an alternative, a charge retention device can be used.
- ▶ Securing of the first in, first out (FIFO) principle.

Transport

- ▶ In line with UN 2794, Banner declares all conventional starter batteries as wet and filled with acid. Running Bull AGM batteries pursuant to UN 2800.
- ▶ Filled batteries are to be transported and stored in an upright position, otherwise acid spillages can occur.
- ▶ During transport batteries must be secured against tipping and slippage.
- ▶ Short circuit protection is essential.
- ▶ Detailed information is available in our product datasheet regarding instruction for the use of starter batteries:
www.bannerbatterien.com/Instructions-Starterbatteries

Instructions for the
use of car batteries



Decommissioning

- ▶ Charge the battery and store it in a cool place.
- ▶ Should the battery remain in the vehicle, remove the minus clamp.
- ▶ Check the open circuit voltage regularly.

BATTERY MAINTENANCE.

Check on the correct connection of the battery cable.

- ▶ Loose battery cables result in increased transitory resistance, which leads to incomplete charging and reduced cold starting current.
- ▶ A layer of dirt may not form on the battery. Permanent creepage current creates increased self-discharge.
- ▶ Permanent creepage current induces increased self-discharge.
- ▶ Terminals must be kept clean and greased.
- ▶ Oxidized terminals also result in increased transitory resistance, which leads to incomplete charging and reduced cold starting current.
- ▶ In the case of conventional and EFM batteries, regular electrolyte level checks should be made and if necessary, top up with demineralized or distilled water to the maximum acid mark, or 15 mm above the upper plate edge. Never refill with acid. If high water losses occur, a specialist should check the governor voltage.

BATTERY CHARGING.

Always heed the safety warnings!

- ▶ Before charging batteries, check the electrolyte level and if necessary top up with de-ionized or distilled water to the maximum acid level mark, or 15 mm above the upper edge of the plates at a maximum.
- ▶ Banner recommends that standard flooded batteries be charged outside the vehicle with 16 V for 24 hours.

Warning! Many chargers have a type of resuscitation mode for deep discharged Ca/Ca batteries. However, these only maintain a charging voltage of 16 V for a short period.

Exception: Running Bull AGM/BackUp:

Always recharge with a voltage-controlled charger (max. 14.80 V). The use of a standard charger without voltage control destroys the battery due to overloading and cause the electrolyte to escape.

Warning! Follow the vehicle manufacturer's instructions when disconnecting the terminals.

- ▶ Batteries may only be charged with direct current. Connect the positive (+) battery terminal to the positive (+) terminal of the charger, and the negative (-) battery terminal to the negative (-) terminal of the charger.
- ▶ Do not switch on the charger until the battery has been connected. First switch off the charger when charging is completed.
- ▶ It is recommended that the charging current be equal to at least one tenth of the capacity (e.g. 44 Ah: 10 = 4.4 A charging current).



How-to Video Car
battery changing



How-to Video Hibernate
a battery

- ▶ The temperature of the acid may not be higher than 55°C during charging. If the temperature exceeds this level, the charging process must be discontinued.
- ▶ Charging is finished when the current drops to 0 or stops falling, or if the automatic charger switches off.
- ▶ Charging must be performed in a well-ventilated room.
- ▶ The battery screws should not be opened.
- ▶ Ensure that recharging amounts to 1.2 times the consumed capacity (e.g. Consumed capacity 30 Ah, recharge 36 Ah).

Warning! Highly explosive oxyhydrogen gas is formed during charging! Fires, sparks, open flames and smoking are strictly prohibited!

Recharging batteries inside the vehicle.

As a rule, fully automatic chargers (max. charging voltage 14.80 V) are well suited to the charging of batteries installed in the vehicle. Should the charger have an automatic mode with > 14.80 V voltage, the battery must be separated from the vehicle electrical system or removed from the vehicle. Otherwise, in a worst-case scenario the installed control devices can be destroyed due to overvoltage with huge resultant damage. **Please take careful note of the battery charger type.** Useful tips regarding charging in the vehicle are often contained in the operating instructions of the vehicle manufacturer or those of the charger producer.

All the stated values relate to a room temperature of + 25°C.
Warning! Temperature compensation is required in the case of deviations!

ASSISTED STARTING.

- ▶ In view of the sensitive electronic components in the vehicle, as a rule starting assistance should only be provided by means of a Banner Booster.
- ▶ Starting assistance from vehicle to vehicle can lead to voltage peaks during disconnection, which can damage or even destroy vehicle electronic systems.
- ▶ Therefore, it is essential that the following procedure be strictly observed when using starter cables!
- ▶ Standardized starter cables (e.g. in accordance with DIN 72 553) should always be used for giving starting assistance.
- ▶ Observe the instructions for use of the starter cables.
- ▶ Only connect batteries with the same nominal voltage.
- ▶ When connecting the terminals, switch off both vehicle engines! First connect the two positive terminals (1) with (2). Then connect the negative terminal of the assisting vehicle (3) with (4), the blank metallic point on the vehicle needing assistance, away from the battery. (Observe the instructions of the vehicle manufacturer.)
- ▶ Now start the vehicle needing assistance for a maximum of 15 seconds. Do not start the assisting vehicle.
- ▶ When disconnecting the terminals, remove the cables in the reverse sequence to the above.



Banner recommendation: Car batteries are not always installed in the engine bay and may be found in the interior/passenger compartment or boot. However, the assisted starting procedure always remains the same!

How-to Video Performing a jump start

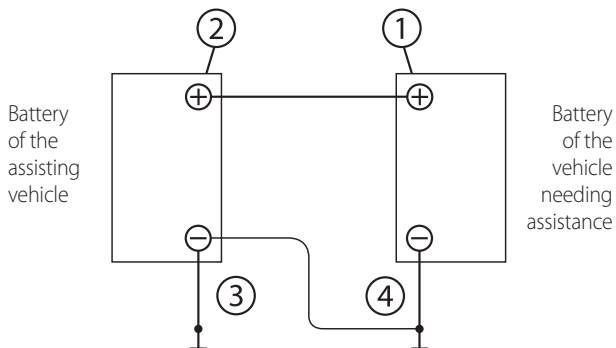

INFLUENCES ON THE ENERGY HOUSEHOLD.

Apart from battery capacity, the power requirement of the electricity consumers, alternator performance and respective driving profile all have a major influence on the energy household of a vehicle. Overall consumption and individual driving conditions are decisive in this regard.

Favourable load conditions

The alternator produces more power than is needed by the electricity consumers. The surplus current is used to charge the battery.

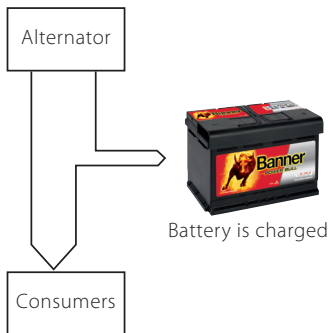

Unfavourable load conditions

The current from the alternator is insufficient to supply all the electricity consumers, e.g. fog lights, seat heating, wing mirrors and rear window heating. Accordingly, in order that all the consumers can be operated, additional energy is taken from the battery.

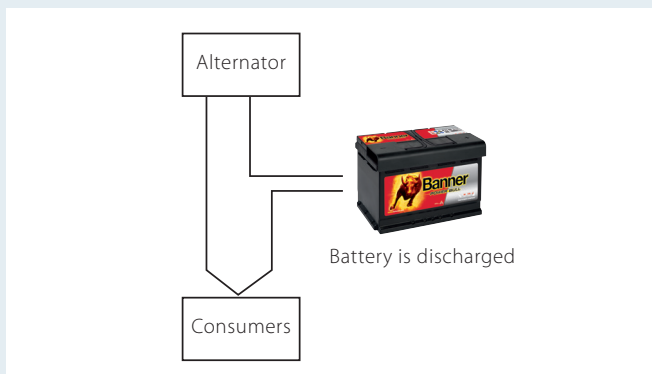

INCREASED OUTPUT REQUIREMENTS.

The demands made on starter batteries also increase significantly with every new vehicle generation. Indeed, the progressive enlargement of electrical systems presents starter batteries with a growing challenge. In modern cars the energy needs of electronic consumers exceeds the output capacity of the alternator with the result that the battery is additionally burdened. Today, an electrical requirement of over 5.000 W and more than 100 e-motors is far from unusual. This frequently leads to a negative energy balance at the expense of the starter battery and as a final consequence, battery failure due to deep discharge.



Banner recommendation: Completion of a battery check by a specialist at least twice yearly and external, equalizing charging where necessary.





Banner

THE POWER

Stationary heating	800 W
4-channel sound system, and level	200 W
Radio with CD player	60 W
Air-conditioning	100 W
Engine timing / ignition	20 W
Heated front window	1,000 W
Fuel injection	100 W
Interior blowers	150 W
Front windscreen wipers	80 W
Radiator fan	500 W
Front headlights	130 W
Headlight washing system	50 W
Fog headlights	100 W
ESP / ABS	100 W
Steering wheel heating	50 W
Mobile navigation device	10 W

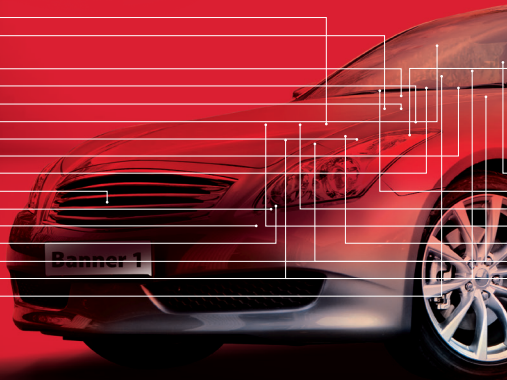

anner

OWER COMPANY

Banner tip.

We recommend the installation of the most powerful and thus the largest battery possible! This provides additional output reserves.

**IT'S HARD TO BELIEVE WHAT YOUR
Banner BATTERY POWERS!**

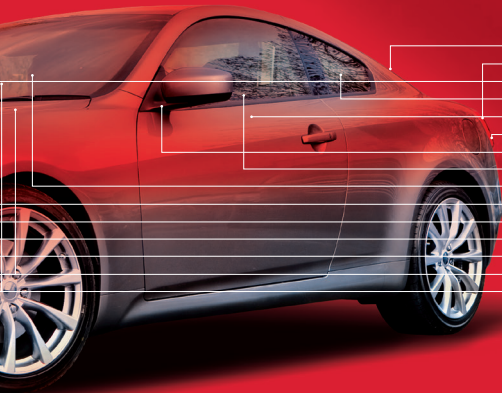

50 W	Rear windscreen wiper
40 W	Rear lights
40 W	Indicators
200 W	Rear window heating
60 W	Seat heating
40 W	Rear fog lights
30 W	Heated wing mirrors
100 W	Electric windows
2 W	iPod
40 W	Heated washing jets
60 W	Fuel pump
180 W	Engine management
120 W	Powered steering pump
200 W	Oil pump
250 W	Water pump

All the values listed above are averages.

IRREGULAR DRIVING PATTERNS.

Owing to the continuing trend towards mobilization, second and third cars are often standard in our households. However, these cars are often driven only irregularly and in combination with stop and go traffic, and occasionally short distances, as well as a large number of cold starts (vehicles not garaged), their batteries often demonstrate a negative charge balance. Such repeated undercharging may result in battery failure due to deep discharge.



Banner recommendation: In the case of extremely short drives (complete/request) external, equalizing charging at regular intervals.



Banner recommendation: In the case of seasonally used vehicles, employ chargers with a charge retention function.

CLOSED CIRCUIT CURRENT.

Closed circuit current is the power that is taken from the battery when the engine is switched off.

The causes of closed circuit current are control devices or electrical consumers, which in spite of apparent inactivity have to constantly react to external influences, e.g. remote radio operation, anti-theft devices and in-board computers. High closed circuit current derived from the run-up of control devices, e.g. for remote radio operations, or owing to a defect in the electrical system, can result in the battery losing an increased amount of energy and failure after a longer standstill period. In busy traffic areas (airports, multi-storey car parks), the use of control devices causes increased closed circuit current owing to the utilization of similar frequencies by all the vehicles.

Therefore, a separate mode is employed for the transport of new vehicles. You can partly learn how to put the vehicle into this mode yourself using your vehicle's operating manual. In other words, a look at the instructions can save unpleasant surprises.

START-STOP SYSTEMS.

Start-stop systems have been developed to reduce markedly vehicle CO₂ emissions and fuel consumption. The basic idea is that the engine will be turned off during each of the phases when it is not required.

Apart from energy management and a sensor that measures the state of charge (SOC), health (SOH), function (SOF) and temperature of the battery, the realization of a start-stop system demands special batteries. AGM batteries are needed for start-stop systems with highest energy demand and recuperation and EFB batteries for simpler start-stop system and high energy demand.

Up to 200 shutdown criteria must be fulfilled for functionality. The energy management communicates with the battery sensor and the engine control unit and either switches off or reactivates individual consumers and the engine as required. In addition, the idling speed can be increased.

Today, virtually all new vehicles are fitted with a start-stop system.

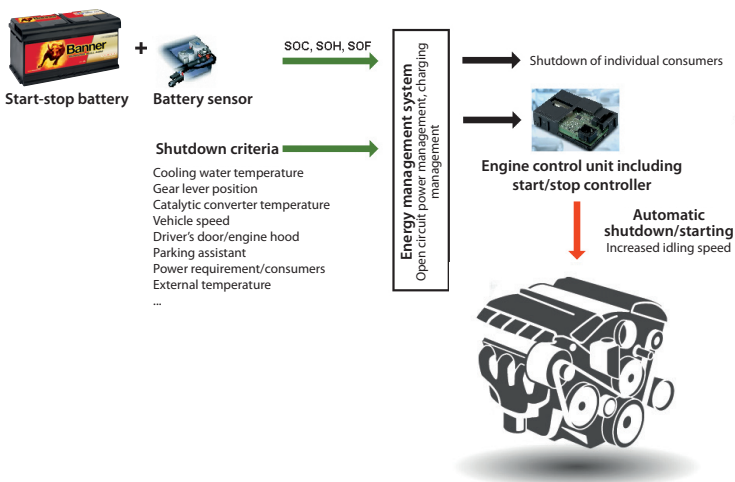

Start-Stop-Systems



How-to registering start-stop batteries



Battery Tip Start-Stop

The Banner BATTERY SERVICE TOOL (BBST) – THE PERFECT ANSWER FOR BATTERY CHANGES.



The Banner BATTERY SERVICE TOOL (BBST) is the ideal aid for battery changes in vehicles with a battery management system. This practical device not only recommends a suitable replacement battery, but can also erase the specific error code of the manufacture and read the new battery into the vehicle system.

Battery exchange

Configuration of the battery in vehicles with battery management systems.

BEM code

Automatic generation of the specific manufacturer battery management code.

Analysis

Read out and erasure of the specific manufacturer error code.
Y-adaptor for the retention of electrical system voltage via a Memory Saver.

Battery classification

Coverage of over 41.000 cars and more than 30.000 commercial vehicles.



How to registering start-stop batteries

POSSIBLE BATTERY PROBLEMS.

UNDERCHARGING

Changed driving patterns (more short distances) and the resultant increase in the electrical energy requirement may lead to the incomplete charging of the battery. It is frequently the case that the alternator is unable to charge the battery to more than 80 per cent of its capacity. Consequently, parts of the active mass are rendered inactive (sulphating) thus reducing the output and capacity of the battery.

OVERCHARGING / HIGH TEMPERATURE

If the battery is already fully charged and nonetheless receives additional energy, this leads to additional gassing and higher water consumption. The battery continues to produce gas until either the charger is switched off or no water is left. Increasing heat results in the acceleration of the chemical processes in the battery and the gas voltage drops. If the charging voltage is not adjusted to match the change in temperature, the battery will be overcharged, which will create the danger of mesh corrosion and severe battery ageing. For example, in the case of an increase in battery temperature of 10°C, both the reaction speed and mesh corrosion double. Strong gassing also causes a considerable increase in the danger of an explosion. For these reasons, a temperature compensation for the charge voltage should be taken into account for all batteries. Moreover, sealed gel and AGM batteries can be damaged by just one overcharge. This is especially problematic, as in these batteries the electrolyte (acid) is bound in and topping up is not possible.

BATTERY DEEP DISCHARGE - SULPHATING

Battery discharge results in lead sulphate. If the battery is not immediately charged, the lead sulphate crystals assume a stable structure and grow, thus reducing the porosity of the lead surface. These crystals can only be converted back with difficulty if at all. Therefore, depending on battery status and design, within just a few days this can lead to the battery being unable to accept any current and becoming useless. Moreover, even if the battery is charged immediately and appears to be fully operative, as a rule, damage remains with a negative effect on service life and therefore in general, deep discharges should be avoided. Furthermore, an increasing number of electronic components are being installed in vehicles, which require electrical power even when the engine is switched off. Such "hidden" consumers include alarm systems and radio clocks (closed circuit current).

POSSIBLE BATTERY PROBLEMS.

STORAGE WITH AN INSUFFICIENT STATE OF CHARGE

The storage of batteries in a partly charged condition contributes to premature ageing. In particular, this problem occurs frequently in the case of leisure applications, e.g. with motorcycles, veteran cars and boats, which are subject to extended standstills. As soon as the charging status falls below 12.5 V, the ageing process and battery sulphating accelerate rapidly.

STRONG CYCLIZATION

This emanates from numerous deep discharge and charging cycles. Under normal circumstances, such loads do not generally occur unless the starter battery is used for other purposes, e.g. in taxis, for the operation of truck loading platforms, as a traction battery (there are special batteries for these applications), or as an electrical system battery in boats and caravans.

UNDERDIMENSIONING OF THE BATTERY

This derives from insufficient battery capacity and leads to increased cyclization and battery damage. It can also be caused by the excessive power consumption created by retrofitted devices (e.g. sound systems, stationary heating, cool boxes).

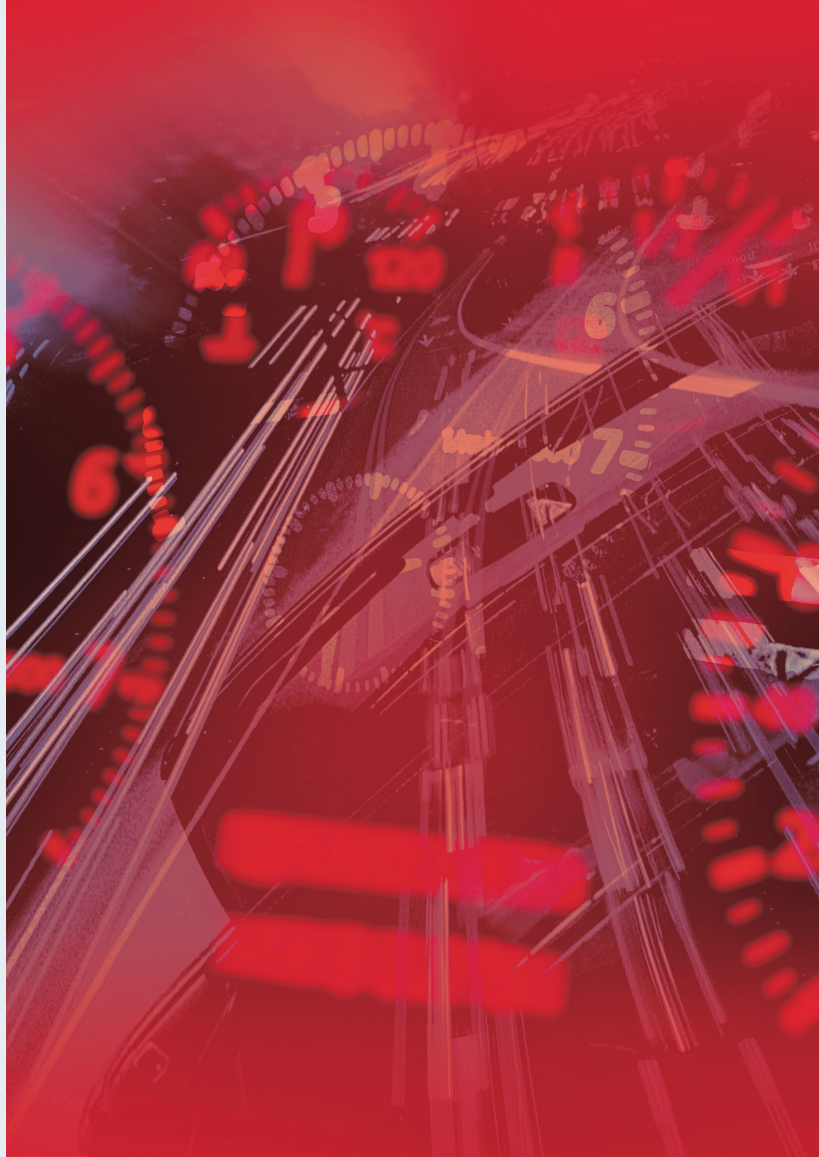

BATTERY TESTING.

CONTROL BATTERY USE

- ▶ Correct battery for the application
- ▶ Driving profile

VISUAL CHECK

- ▶ Damage, tightness
- ▶ Check the tightness of the battery cables
- ▶ Battery clean and dry (creepage current, increased transient resistance)
- ▶ Detached labels and increased water consumption indicate overcharging and/or high temperatures.

CHECK THE OPEN CIRCUIT VOLTAGE (OCV)

- ▶ Measure six hours after battery charging/discharge.
- ▶ Fully charged wet battery: OCV >12.70 V
- ▶ Fully charged AGM battery: OCV >12.90 V

MEASURE ACID DENSITY

- ▶ Acid density uniformly low > battery discharged
- ▶ Acid density in a cell markedly lower > short circuit
- ▶ Acid coloured brown > sludging due to strong cyclization
- ▶ Acid density does not correspond with the OCV > acid stratification (acid density +0.84 =OCV/cell), e.g. acid density 1.20; OCV 12.67 V: $1.20+0.84=2.04$ V/cell > x 6 cells = 12.24 V > acid stratification!
- ▶ Acid density uniformly high (~1.28 kg/l) → battery in order

QUICK TESTING DEVICE

- ▶ Only limited validity. No assessment of service life and capacity possible.
- ▶ Design (mass, separator, etc.), temperature and charging status have a major influence on the test result.

BATTERY CHARGING

RENEWED CHECK ON THE ACID DENSITY AND CONTROL WITH THE QUICK TESTING DEVICE

COMPLETE LOAD TEST

OBSERVE THE SAFETY INSTRUCTIONS!

IMPORTANT TERMS.

AGM

These batteries containing nonwovens bear the designation absorbent glass mat (AGM) or valve regulated lead acid (VRLA). Above all, they are used in start-stop systems with highest energy demand and recuperation and are characterized by the highest levels of cyclical and vibration resistance, as well as very high cold start current. In addition, these batteries are absolutely leak-proof as the electrolyte is bound in. The safety valves may never be opened and special care must be taken when charging these batteries. The charge voltage may not exceed 14.8 V.

CARBON LOADED

The carbon additives enhance battery chargeability and current absorption capacity, as well as the conductivity of the active mass.

EFB (=AFB/ ECM)

The enhanced flooded battery is a further development of the conventional wet battery. As opposed to the latter, the battery has improved cyclical and vibration resistance owing to a separator with a non-woven layer and a special mass recipe. It is used for less complex start-stop systems with high energy demand.

Electrolyte

The ion conductor, which connects electrodes. Diluted sulphuric acid is employed in lead-acid batteries.

ESD = Electrostatic discharge

Electrostatic discharges result from the disruptive voltages emanating from major potential differences. These disruptive voltages (occasionally visible as sparks) cause a short burst of powerful electric current and can result in the ignition of flammable substances. It is precisely this that ESD plugs prevent.

EN 50342-1

This standard applies to lead-acid batteries with a rated voltage of 12V, which are used primarily for the ignition of combustion engines, lighting and the additional equipment contained in vehicles with combustion engines.

Cranking performance

Cold cranking test current is a parameter for the starting capacity of batteries in cold temperatures. In line with the EN50342-1 standard, this test is completed at -18°C.

Capacity

The electricity output volume (Ah) constitutes battery capacity. The rated capacity of starter batteries always relates to a 20-hour discharge. The available capacity is dependent upon the strength of the discharge current, temperature and battery age. Pursuant to the EN 50342-1 standard, at a temperature of 25 +/- 2°C a new battery must be able to provide discharge current of $I = K202/20$ h without the voltage falling below 10.5 V.

IMPORTANT TERMS.

Recuperation

Braking energy recovery. The coasting energy derived from braking is converted into electrical energy by the generator and stored in the battery.

OCV

Open circuit voltage is the off-load voltage at the battery terminals following the attainment of a steady-state value (min. 6 hours).

Self-discharge

Off-load discharge of the battery due to chemical processes in the battery. Self-discharge is highly dependent upon temperature, design and technology.

Separator

Ion-permeable material separates the positive and negative plates. Polyethylene is used in wet batteries, glass mat in AGM versions.



Battery knowledge

SOC

State of charge: battery charge status.

SOF

State of function: functional status of the battery.

SOH

State of health: health status of the battery.

Deep discharge

Discharge of the battery to a very low depth (> 50 %).

OUR SALES REGION.

Austria

Banner GmbH, Banner Straße 1, A-4021 Linz
Phone: +43/(0)732/38 88-0
E-Mail: office@[bannerbatterien.com](mailto:office@bannerbatterien.com)

Bulgaria

Banner Baterii Bulgaria EOOD / Баннер Батерии Б-я ЕООД, Ul. Ljublana 46, J&L Center, 1. Stock /
Ул. Любляна 46, J&L Center, ет. 1., BG-1618 Sofia / София, Telefon: / Тел. +359/2/889 01 20,
Fax: / Факс: +359/2/889 01 21, E-Mail: office.bbg@[bannerbatteries.com](mailto:office.bbg@bannerbatteries.com)

Czech Republic

Banner Baterie ČR, s.r.o., Uhříněves, Přátelství 1011, CZ-10400 Praha 10
Phone: +420/267 090-510, Fax: +420/267 090-522
E-Mail: office.bczp@[bannerbatteries.com](mailto:office.bczp@bannerbatteries.com)

Denmark

Banner Batterier Danmark ApS, Silovej 14, DK-2690 Karlslunde
Phone: +45/70 20 60 61, E-Mail: office.bdk@[bannerbatteries.com](mailto:office.bdk@bannerbatteries.com)

Espania

Banner Baterías España, S.L., Hilanderas 5, Nave C
Pol. Ind. Los Angeles, 28905 Getafe
Phone: +34 911 081 608
E-Mail: office.bes@[bannerbatteries.com](mailto:office.bes@bannerbatteries.com)

France

Banner France SAS, Zone Industrielle No. 2, 5, Rue Vauban, F-68170 Rixheim
Phone: +33/(0)3 89/44 28 38, Fax: +33/(0)3 89/54 13 28
E-Mail: office.bf@[bannerbatteries.com](mailto:office.bf@bannerbatteries.com)

Germany

Banner Batterien Deutschland GmbH, Kesselbodenstraße 3, D-85391 Allershausen (München)
Phone: +49/(0)6441/30 73-23000, Fax: +49/(0)6441/30 73-23099
E-Mail: office.bda@[bannerbatterien.com](mailto:office.bda@bannerbatterien.com)

Hungary

Banner Batterien Hungária Kft, Ipari park, Jedlik Ányos u. 6, H-2330 Dunaharaszti
Phone: +36/24/49 18 91, Fax: +36/24/49 18 92
E-Mail: office.bhb@[bannerbatteries.com](mailto:office.bhb@bannerbatteries.com)

Poland

Banner Polska Sp. z o.o., ul. Gliwicka 234, PL-40861 Katowice
Phone: +48/(0)32/203 72 45, Fax: +48/(0)32/203 72 46
E-Mail: office.bpl@[bannerbatteries.com](mailto:office.bpl@bannerbatteries.com)

Romania

Banner Baterii Romania s.r.l., B-dul Biruinței nr. 67, RO-077145 Pantelimon, jud. Ilfov
Phone: +4/021/3000 627, +4/021/310 11 49, Fax: +4/021/3000 637
E-Mail: office.bro@[bannerbatteries.com](mailto:office.bro@bannerbatteries.com)

Russia

ООО "Banner Batterien" / ООО «Баннер Баттериен», Krasnogorskiy rajon, Promzona-37,
pos.Archangelskoe / Промзона-37, пос.Архангельское, Красногорский район
RUS-143420 Moskovskaja Oblast / Московская область
Phone: / Телефон: +7/(499)504 98 69, Fax: / Факс: +7/(499)504 98 69
E-Mail: office.bru@[bannerbatteries.com](mailto:office.bru@bannerbatteries.com)

Slovakia

Banner Baterie SR, s.r.o., Vajnorská 134/B, Nr. 1537, SK-83104 Bratislava 3
Phone: +421/(0)2/43 63 43 44, Fax: +421/(0)2/43 42 18 74
E-Mail: office.bskb@[bannerbatteries.com](mailto:office.bskb@bannerbatteries.com)

Switzerland

Banner Batterien Schweiz AG, Banner Straße 1, CH-5746 Walterswil
Phone: +41/(0) 62 789 89 89
E-Mail: office.bchw@[bannerbatterien.com](mailto:office.bchw@bannerbatterien.com)

UK

Banner Batteries (GB) Ltd., Units 5-8 Canal View Business Park,
Wheelhouse Road, Rugeley, UK-WS15 1UY Staffordshire
Phone: +44/(0)1889/57 11 00, Fax: +44/(0)1889/57 73 42
E-Mail: office.bgb@[bannerbatteries.com](mailto:office.bgb@bannerbatteries.com)

**Banner products are sold in more than 40 European,
African and Asian states via direct importers.**



Banner

THE POWER COMPANY



Banner

THE POWER COMPANY

1700000216/09-21

IMPRINT:

Media owner, publisher:

Banner GmbH, 4021 Linz, Salzburger Straße 298

Responsible for the contents: Banner GmbH, Andreas Bawart.

All rights reserved. Reprints only allowed with written permission.

Place of publication: Linz



bannerbatterien.com

LEADING
COMPANIES OF AUSTRIA

